



# LOTUA

YNOTM.109  
v.3.0

MONTAGE - ASSEMBLING - MONTAJE



## MODULES



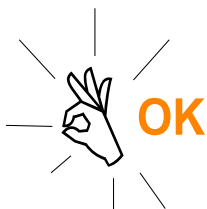
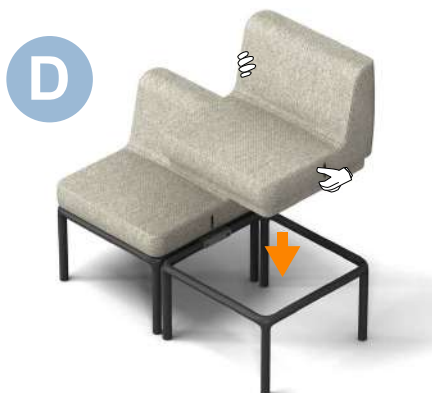
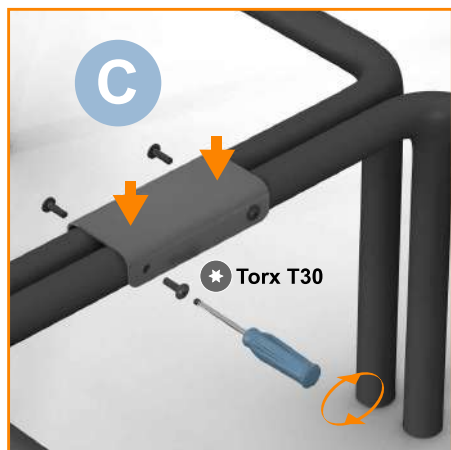
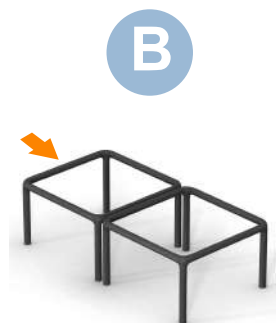
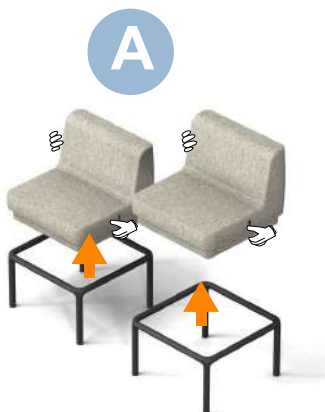

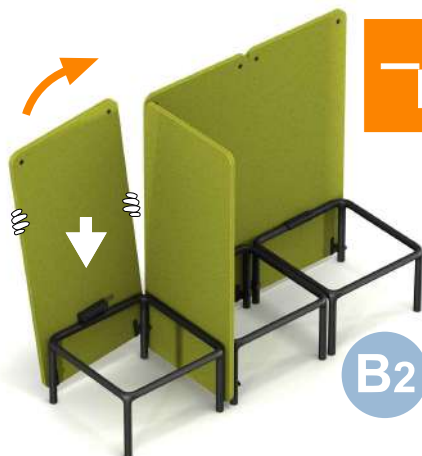
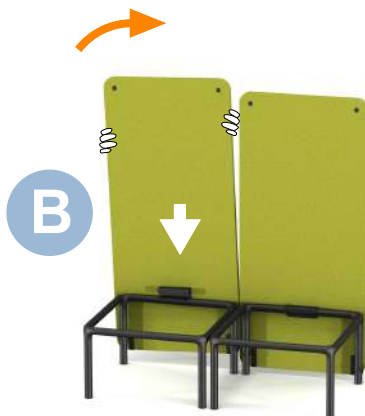
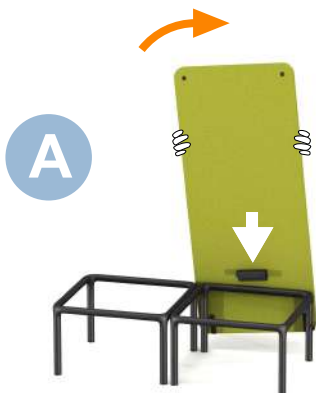

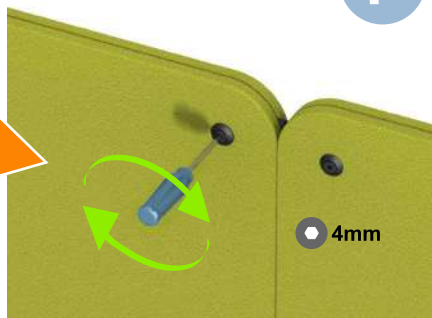
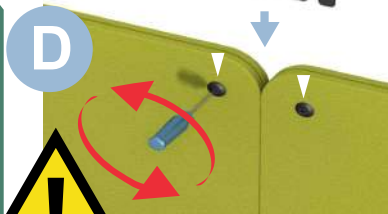

- Desserrez la vis d'environ 5 tours max.
- Loosen the screw about 5 turns max.
- Aflojar el tornillo unas 5 vueltas max.

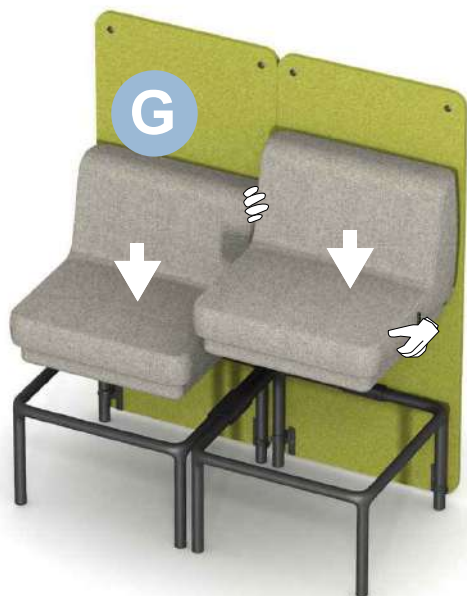

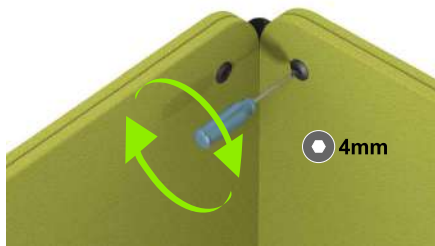
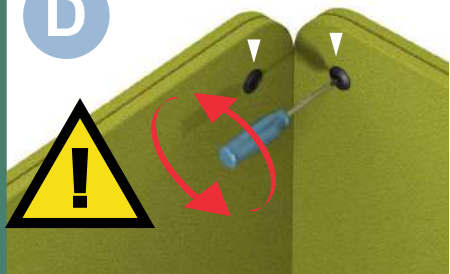

-Desserrez la vis d'environ 5 tours max.  
 -Loosen the screw about 5 turns max.  
 -Aflojar el tornillo unas 5 vueltas max.

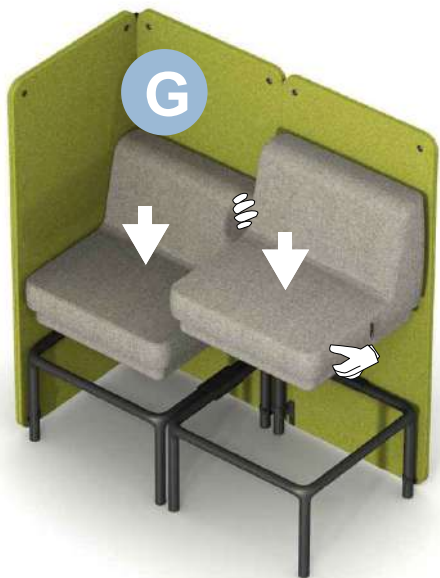

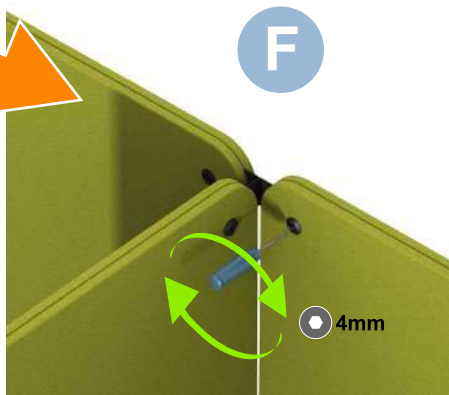
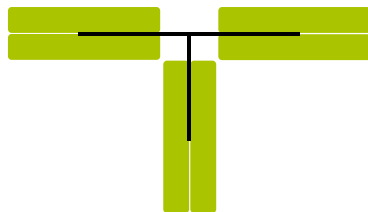
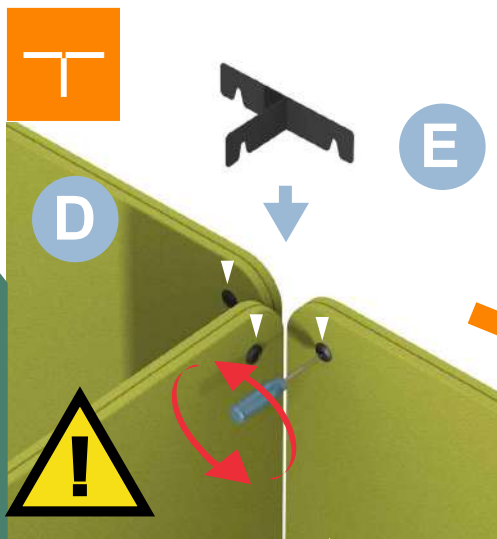

-Desserrez la vis d'environ 5 tours max.  
 -Loosen the screw about 5 turns max.  
 -Aflojar el tornillo unas 5 vueltas max.

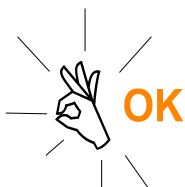
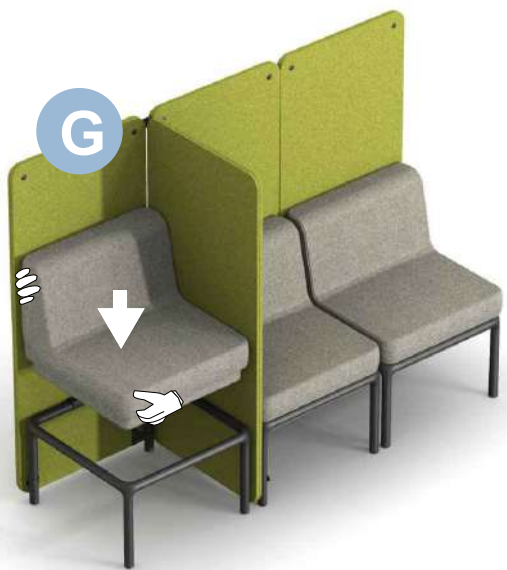

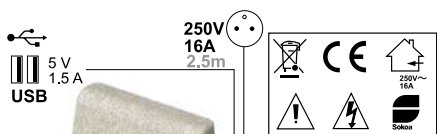
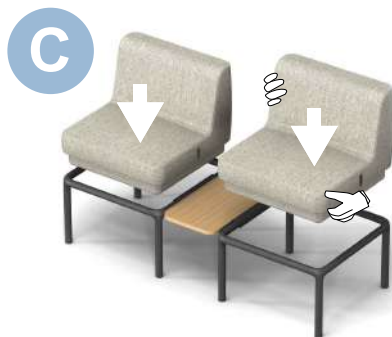
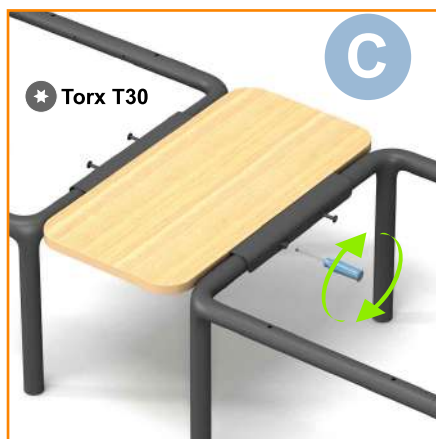
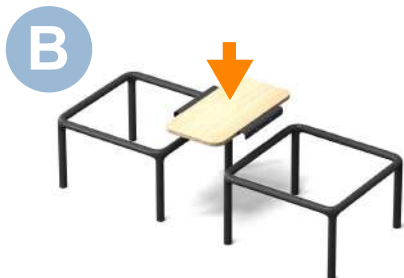
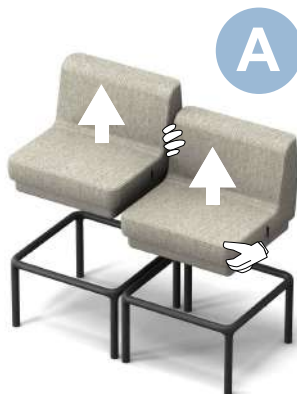
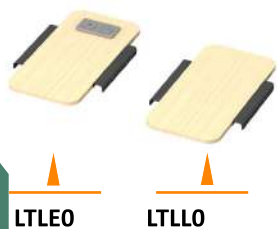

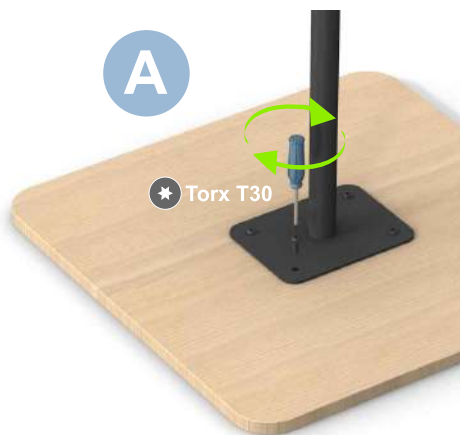
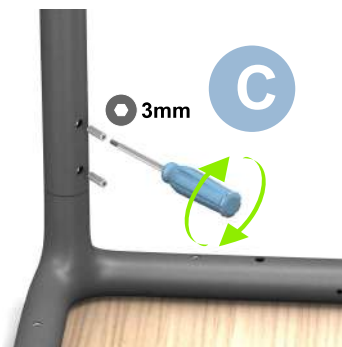
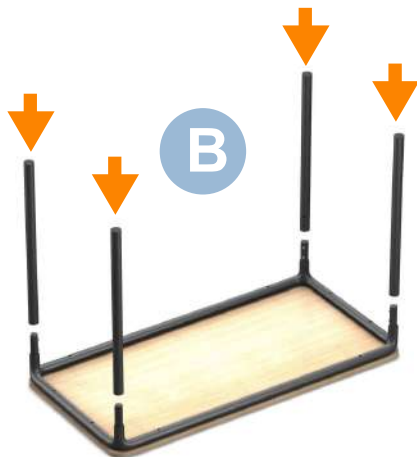
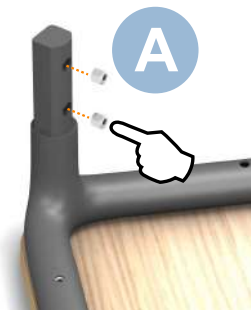



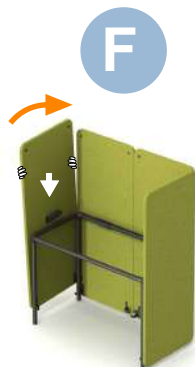
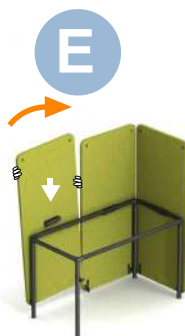
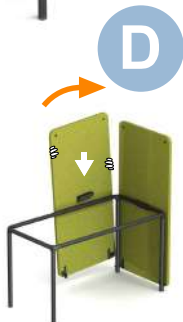
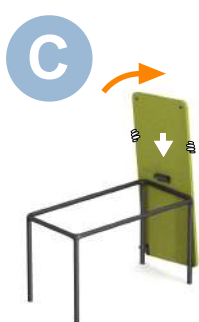
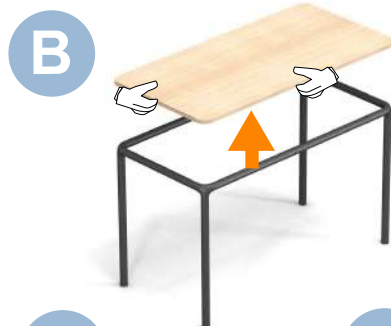
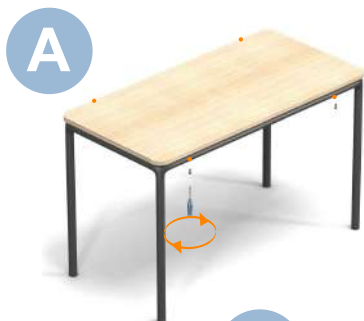

**G**

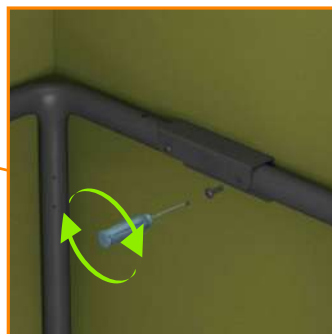

**H**

Page 5  
Página 5



Page 4  
Página 4

**I**

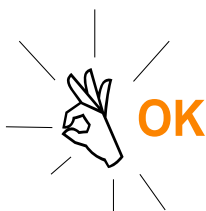
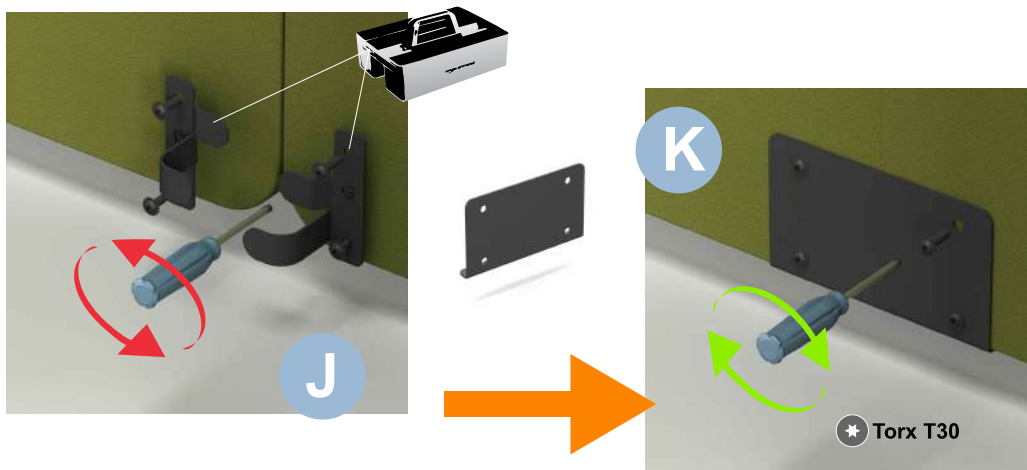

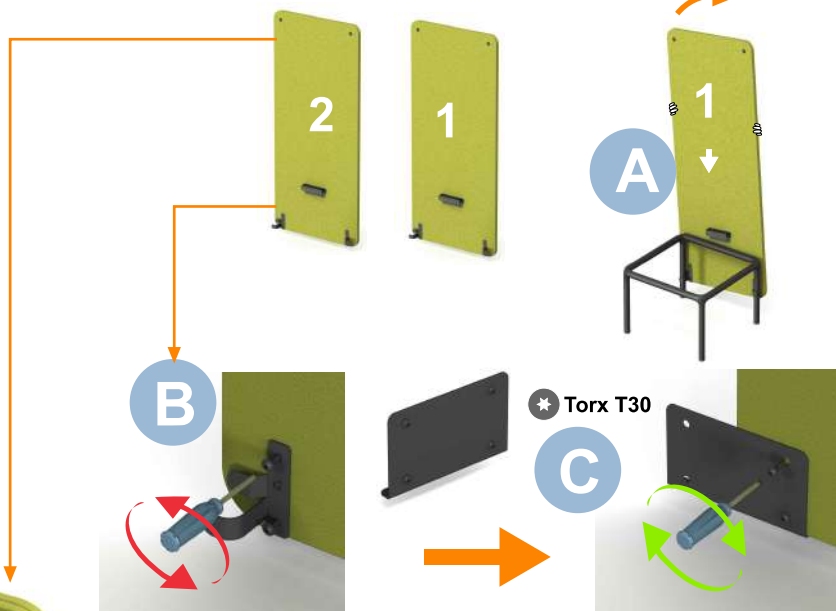

**D**

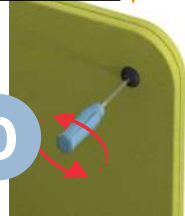

-Desserrez la vis d'environ 5 tours max.  
 -Loosen the screw about 5 turns max.  
 -Aflojar el tornillo unas 5 vueltas max.

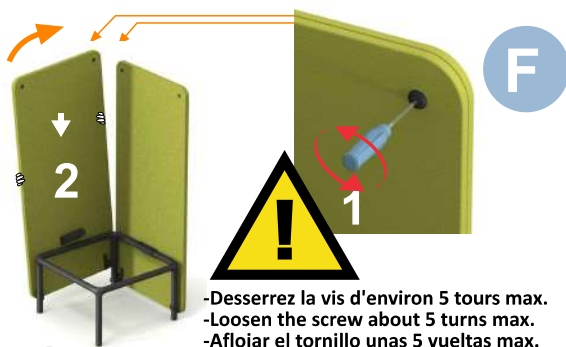

**E**

-Desserrez la vis d'environ 5 tours max.  
 -Loosen the screw about 5 turns max.  
 -Aflojar el tornillo unas 5 vueltas max.

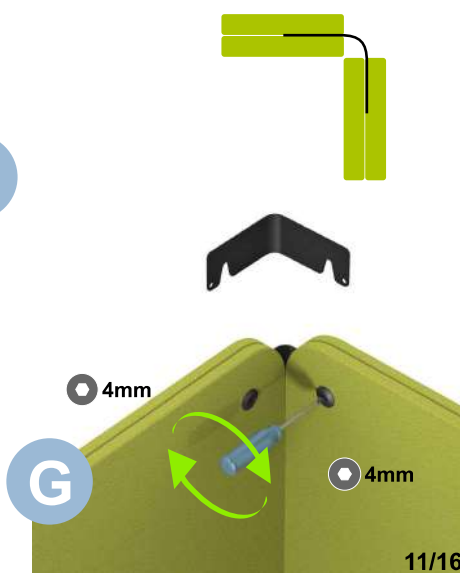

**G**

4mm

4mm

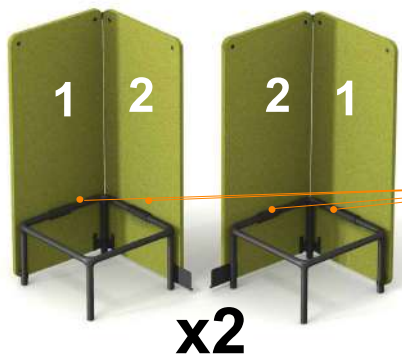

I



J

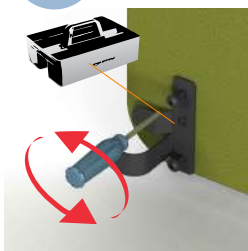

3



K

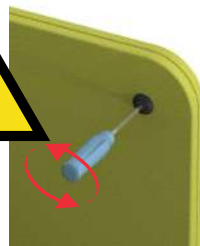

-Desserrez la vis d'environ 5 tours max.  
-Loosen the screw about 5 turns max.  
-Aflojar el tornillo unas 5 vueltas max.

L

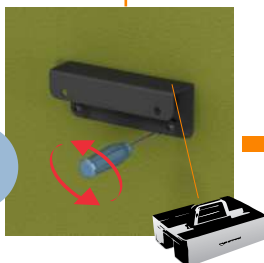

M

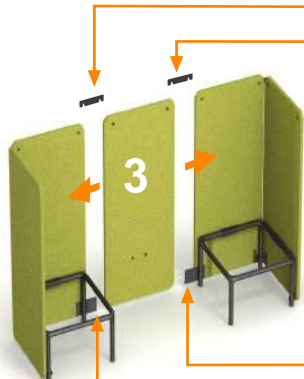
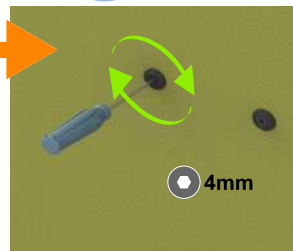

N

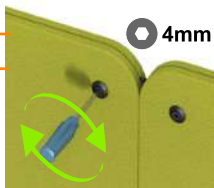

O





P

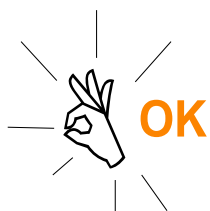

### FIXATION AU SOL FIXING TO THE FLOOR FIJACION AL SUELO

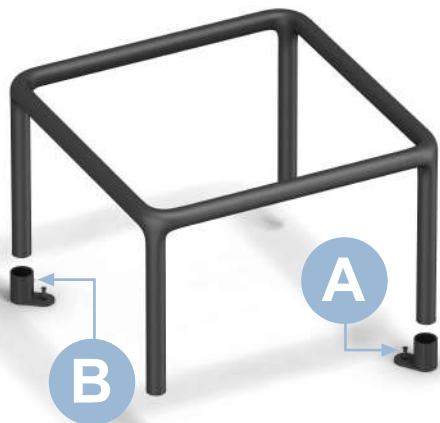

### NIVELATION DES PIEDS FOOT LEVELING NIVELACION DE LAS PATAS

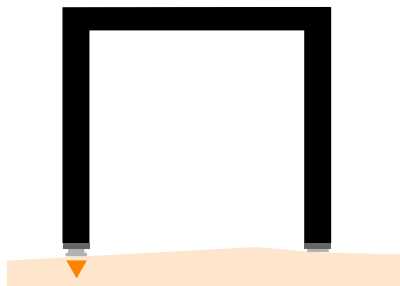

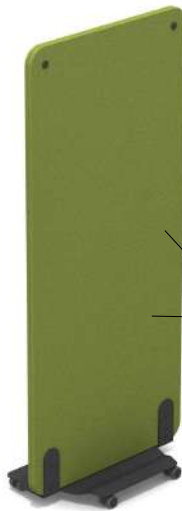
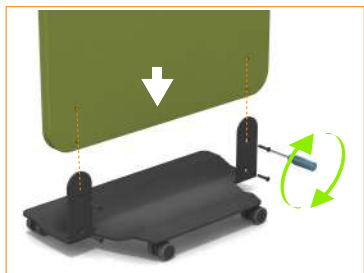
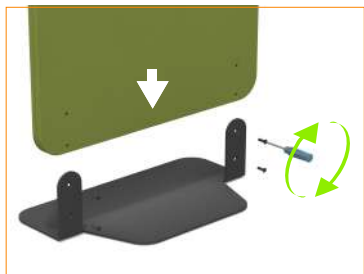

A



B



-Desserrez la vis d'environ 5 tours max.  
 -Loosen the screw about 5 turns max.  
 -Aflojar el tornillo unas 5 vueltas max.

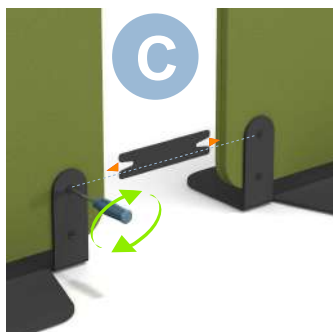

C

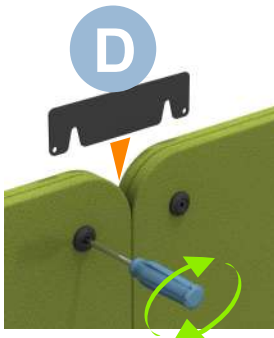

D



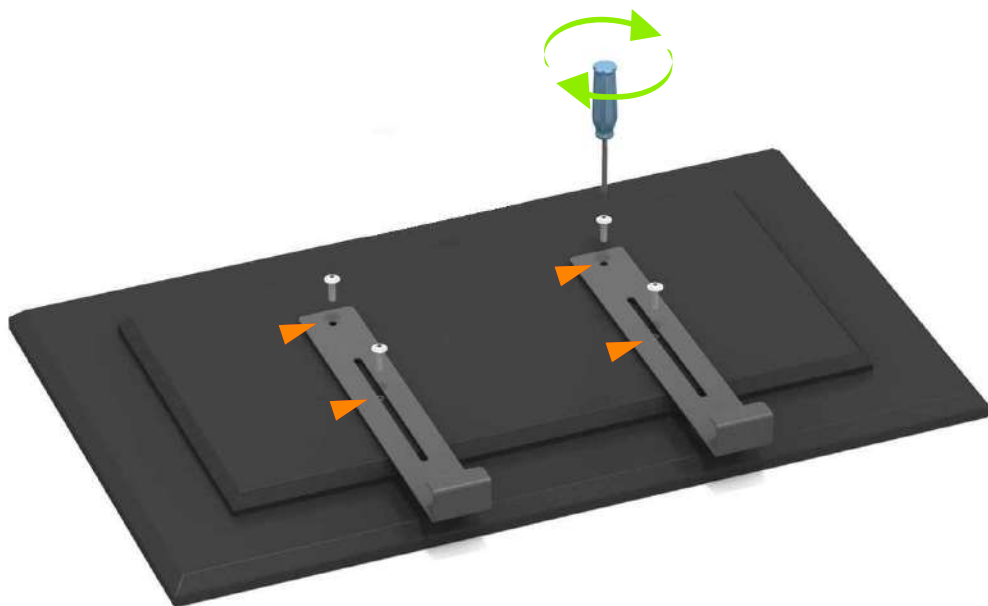

**3 Kg**

**Charge Maximale  
Maximum weighth  
Peso maximo**

